



Valves-Diaphragm

Valves-Diaphragm

Part Number	Description	List Price
122-905	PVC/EPDM/UNION 1/2"	\$115.20
122-906	PVC/EPDM/UNION 3/4"	\$126.10
122-907	PVC/EPDM/UNION 1"	\$156.90
122-908	PVC/EPDM/UNION 1 1/4"	\$222.20
122-909	PVC/EPDM/UNION 1 1/2"	\$250.34
122-910	PVC/EPDM/UNION 2"	\$298.40
122-911	PVC/VITON/UNION 1/2"	\$219.50
122-912	PVC/VITON/UNION 3/4"	\$230.40
122-913	PVC/VITON/UNION 1"	\$263.96
122-914	PVC/VITON/UNION 1 1/4"	\$371.90
122-915	PVC/VITON/UNION 1 1/2"	\$405.50
122-916	PVC/VITON/UNION 2"	\$514.30
122-926	PVC/TEFLON*/UNION 1/2"	\$232.20
122-927	PVC/TEFLON*/UNION 3/4"	\$243.10
122-928	PVC/TEFLON*/UNION 1"	\$278.50
122-929	PVC/TEFLON*/UNION 1 1/4"	\$393.70
122-930	PVC/TEFLON*/UNION 1 1/2"	\$429.04
122-931	PVC/TEFLON*/UNION 2"	\$541.50



DN 15 - DN 50

DN 65 - DN 80

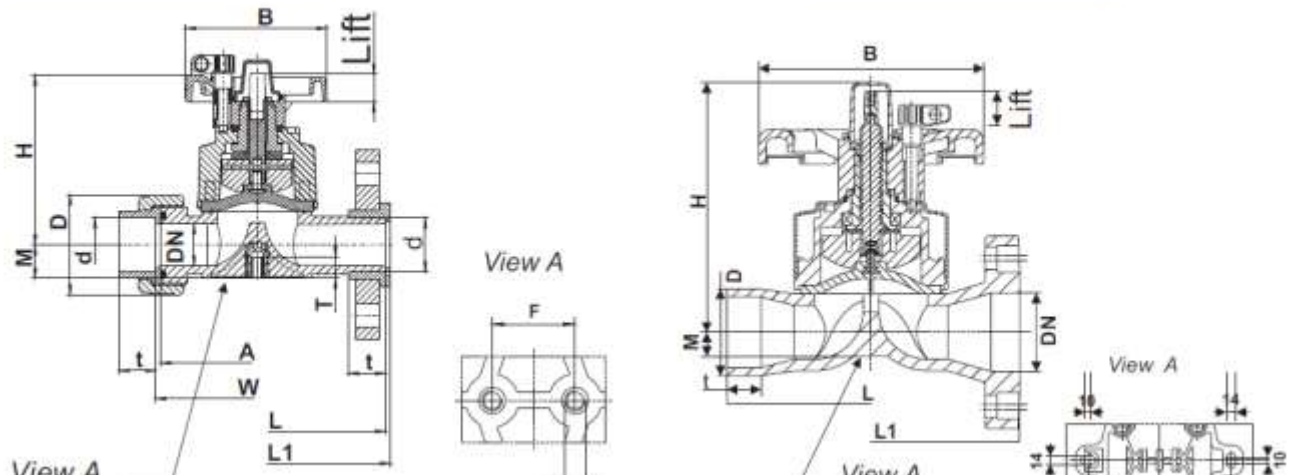

d	20	25	32	40	50	63	75	90	110	140
DN	15	20	25	32	40	50	65	80	100	125
G	1/2"	3/4"	1"	1 1/4"	1 1/2"	2"	2 1/2"	3"	4"	5"
M	17,0	17,0	21,0	33,0	33,0	40,3	25,0	25,0	25,0	25,0
H	100,0	100,0	107,0	144,0	144,0	170,0	260,0	260,0	330,0	330,0
B	86,0	86,0	86,0	136,0	136,0	136,0	234,0	234,0	234,0	234,0
D	43,0	53,0	60,0	74,0	83,0	103,0				
F	25,0	25,0	25,0	45,0	45,0	45,0				
Lift	9,0	9,0	11,0	22,0	22,0	28,0	35,0	35,0	45,0	45,0
K	M6	M6	M6	M8	M8	M8				
L	124,0	144,0	154,0	174,0	194,0	224,0	284,0			
L1	130,0	150,0	160,0	180,0	200,0	230,0	300,0	310,0	350,0	400,0
T	12,0	12,0	12,0	15,0	15,0	15,0				
Z	96,0	114,0	122,0	142,0	160,0	190,0				
A	90,0	108,0	116,0	136,0	154,0	184,0				
t	16,0	19,0	22,0	26,0	31,0	38,0	44,0	54,5		
PN	10,0	10,0	10,0	10,0	10,0	10,0	10,0	10,0	10,0	10,0